

Standard Series FP628 6V2.8Ah

FirstPower®

Dimension(mm)

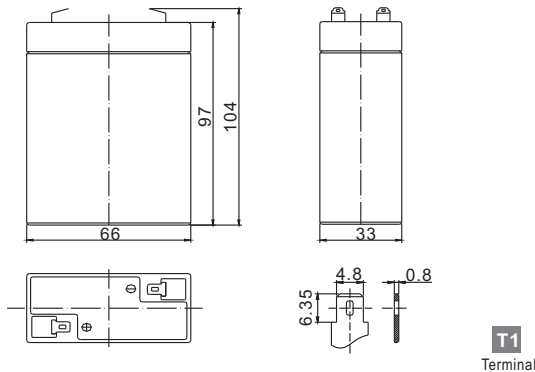

Specification

Nominal Voltage		6 V
Capacity(20HR, 25°C)		2.8Ah
Dimension	Length	66mm (2.60inch)
	Width	33mm (1.30inch)
	Height	97mm (3.82inch)
	Total Height	104mm (4.09inch)
Approx. Weight		0.60kg (1.32lbs)

Characteristics

Capacity 20°C (68□) To 1.70V/Cell	20 hour rate	2.8Ah
	10 hour rate	2.6Ah
	5 hour rate	2.25Ah
	1 hour rate	1.76Ah
	15 min rate	1.32Ah
Internal resistance(Fully charged, 25°C)		Approx. 25mΩ
Capacity affected by temperature (20HR)	40°C	102%
	25°C	100%
	0°C	85%
	-15°C	65%
Self-discharge (25°C)	3 month	Remaining Capacity: 91%
	6 month	Remaining Capacity: 82%
	12 month	Remaining Capacity: 65%
Nominal operating temperature		25°C ±3°C(77°F ±5°F)
Operating temperature range		-15°C~50°C(5°F~122°F)
Float charging voltage(25°C)		6.80 to 6.90V
Cyclic charging voltage(25°C)		7.25 to 7.45V
Maximum charging current		0.84A
Terminal material		Copper
Maximum discharge current		42A(5 Sec.)

The Relationship for Open Circuit Voltage and Residual Capacity (25°C)

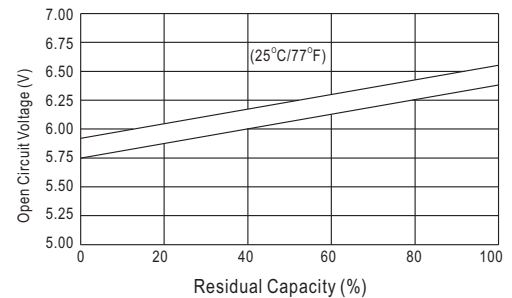

Charging Characteristics(25°C)

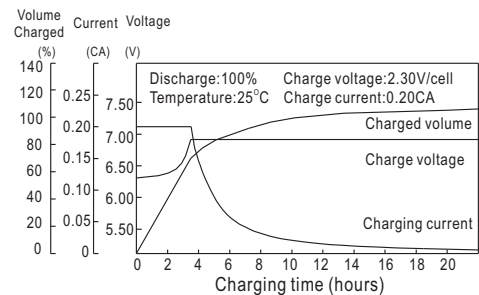

Cycle Life(25°C)

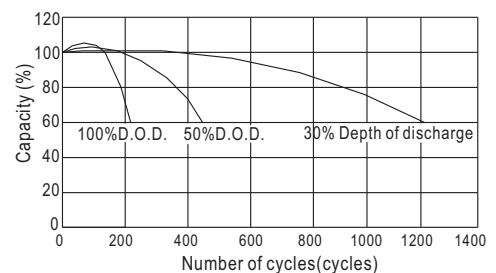

Constant Current Discharge Characteristics (A, 25°C)

F.V/TIME	5min	10min	15min	30min	60min	3h	5h	10h	20h
4.80V	11.5	7.02	5.50	3.10	1.83	0.71	0.46	0.26	0.14
5.10V	10.9	6.84	5.28	2.98	1.76	0.70	0.45	0.26	0.14
5.40V	10.2	6.43	5.02	2.83	1.67	0.69	0.44	0.25	0.14

Constant Power Discharge Characteristics (Watt, 25°C)

5min	10min	15min	30min	60min	3h	5h	10h	20h
64.2	40.6	31.4	17.8	10.6	4.22	2.73	1.52	0.85
61.0	38.6	30.1	17.1	10.2	4.16	2.69	1.51	0.85
57.3	36.3	28.6	16.2	9.7	4.07	2.63	1.51	0.84