

CFPS2300 2V300Ah

Dimension

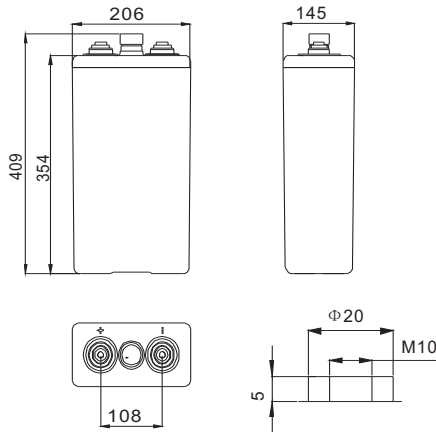

Specification

Nominal Voltage	2 V	
Capacity(10HR, 25°C)	300Ah	
Dimension	Length	145mm
	Width	206mm
	Height	354mm
	Total Height	409mm
Approx.mass(without electrolyte)	19.2kg	
Approx.mass(with electrolyte)	24.3kg	

Charge characteristic curve(20°C)

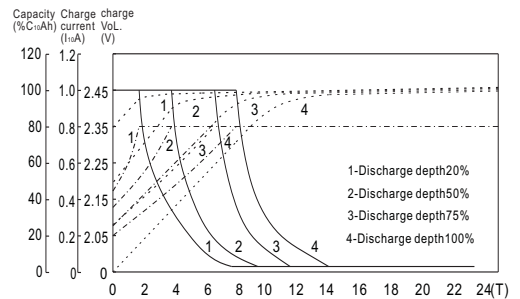

Relation curves of service life and ambient temperature

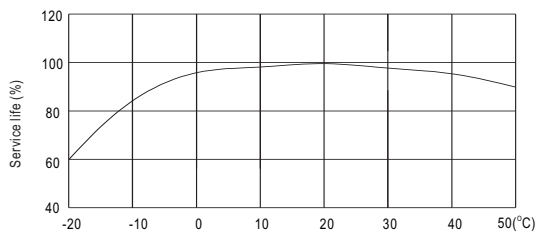

Discharge capacity Vs ambient temperature curve (I10A)

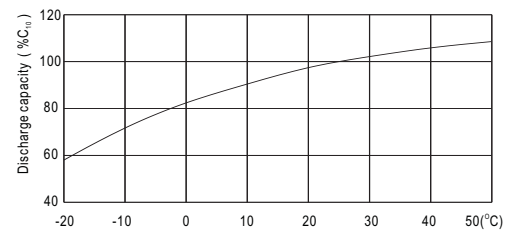

Characteristic curves at different discharge rate (20°C)

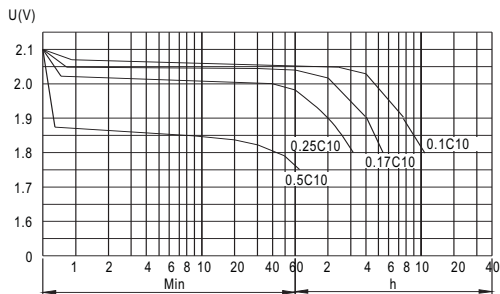

Charge voltage Vs ambient temperature curve

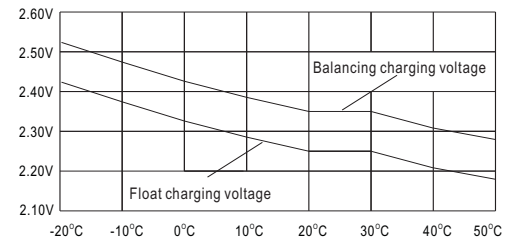

	1hr cut-off voltage 1.67V	3hr cut-off voltage 1.75V	5hr cut-off voltage 1.77V	10hr cut-off voltage 1.80V	24hr cut-off voltage 1.85V	48hr cut-off voltage 1.85V	72hr cut-off voltage 1.85V	96hr cut-off voltage 1.85V	120hr cut-off voltage 1.85V	240hr cut-off voltage 1.85V
Capacity Ah	159	225	258	300	375	402	420	420	425	430