

LPG SERIES-GEL Battery

LPG2-100 (2V100AH)

Specification

Nominal Voltage	2V	
Nominal Capacity(10HR)	100.0AH	
Dimension	Length	170±2mm (6.69 inches)
	Width	72±2mm (2.83 inches)
	Container Height	205±2mm (8.07 inches)
	Total Height (with Terminal)	212±2mm (8.35 inches)
Approx Weight	Approx 6.2 kg (13.67lbs)	
Terminal	T6	
Container Material	ABS	
Rated Capacity	106.7 AH/5.335A	(20hr, 1.80V/cell, 25°C/77°F)
	100.0 AH/10.00A	(10hr, 1.75V/cell, 25°C/77°F)
	86.0 AH/17.2A	(5hr, 1.75V/cell, 25°C/77°F)
	74.7 AH/24.9A	(3hr, 1.75V/cell, 25°C/77°F)
	58.7 AH/58.7A	(1hr, 1.67V/cell, 25°C/77°F)
Max. Discharge Current	700A (5s)	
Internal Resistance	Approx 1.58mΩ	
Operating Temp. Range	Discharge	-20~55°C (-4~131°F)
	Charge	0~40°C (32~104°F)
	Storage	-20~50°C (-4~122°F)
Nominal Operating Temp. Range	25±3°C (77±5°F)	
Cycle Use	Initial Charging Current less than 25.0A. Voltage	
	2.4V~2.5V at 25°C(77°F)Temp. Coefficient -5mV/°C	
Standby Use	No limit on Initial Charging Current Voltage	
	2.25V~2.3V at 25°C(77°F)Temp. Coefficient -3mV/°C	
Capacity affected by Temperature	40°C (104°F)	103%
	25°C (77°F)	100%
	0°C (32°F)	86%
Self Discharge	Leoch LPG series batteries may be stored for up to 9 months at 25°C(77°F) and then a freshening charge is required. For higher temperatures the time interval will be shorter.	



Applications

- ◆ Telecommunications
- ◆ Solar system
- ◆ Wind power system
- ◆ Engine starting
- ◆ Wheelchair
- ◆ Floor cleaning machines
- ◆ Golf trolley
- ◆ Boats



Constant Current Discharge (Amperes) at 25 °C (77°F)

F.V/Time	20min	30min	45min	1h	2h	3h	4h	5h	6h	7h	8h	9h	10h	20h
1.85V/cell	87.0	68.4	52.1	45.3	28.9	22.0	18.3	15.8	13.6	12.0	10.9	9.92	9.39	5.12
1.80V/cell	99.9	76.4	57.6	50.0	31.3	23.6	19.4	16.6	14.3	12.6	11.4	10.4	9.81	5.34
1.75V/cell	112.2	84.0	62.1	53.4	33.2	24.9	20.3	17.2	14.8	13.1	11.8	10.8	10.0	5.44
1.70V/cell	120.9	90.0	66.0	56.6	35.2	26.0	20.9	17.7	15.3	13.5	12.1	11.0	10.2	5.52
1.67V/cell	125.7	93.6	68.4	58.7	36.1	26.8	21.5	18.1	15.6	13.7	12.3	11.2	10.4	5.57
1.60V/cell	136.2	100.0	73.5	62.3	37.5	27.9	22.3	18.7	15.9	14.0	12.5	11.4	10.6	5.65

Constant Power Discharge (Watts) at 25 °C (77°F)

F.V/Time	20min	30min	45min	1h	2h	3h	4h	5h	6h	7h	8h	9h	10h	20h
1.85V/cell	165.2	130.8	100.3	87.5	56.0	42.8	35.6	30.9	26.7	23.7	21.5	19.6	18.6	10.1
1.80V/cell	187.2	144.7	109.8	96.1	60.4	45.7	37.6	32.3	28.0	24.7	22.4	20.6	19.4	10.5
1.75V/cell	207.9	157.3	117.4	102.1	63.8	48.2	39.3	33.4	28.9	25.6	23.1	21.2	19.7	10.7
1.70V/cell	221.6	167.4	124.2	107.8	67.3	50.0	40.4	34.4	29.8	26.4	23.7	21.7	20.2	10.9
1.67V/cell	227.8	171.8	127.6	110.9	68.7	51.4	41.3	35.0	30.2	26.7	24.0	22.0	20.4	11.0
1.60V/cell	244.1	182.3	136.3	117.1	71.1	53.2	42.7	35.9	30.9	27.2	24.4	22.4	20.8	11.1

Dimensions

T6 Terminal

Unit: mm [inches]

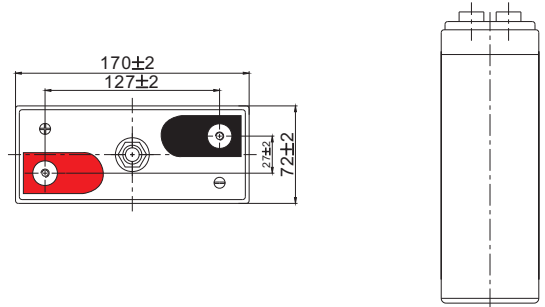
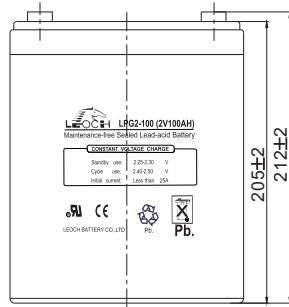
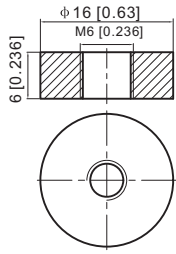

Discharge Characteristics

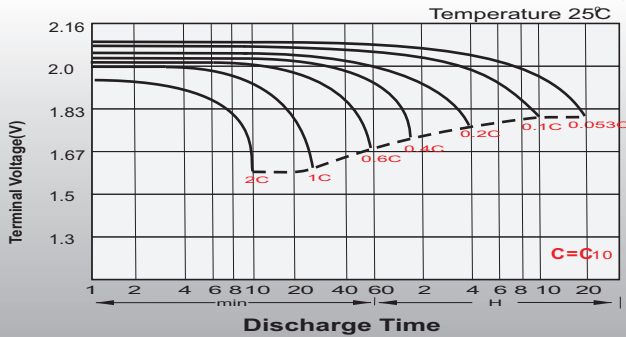

Float Charging Characteristics

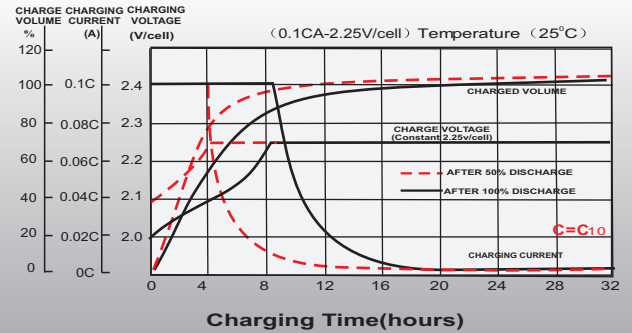

Temperature Effects in Relation to Battery Capacity

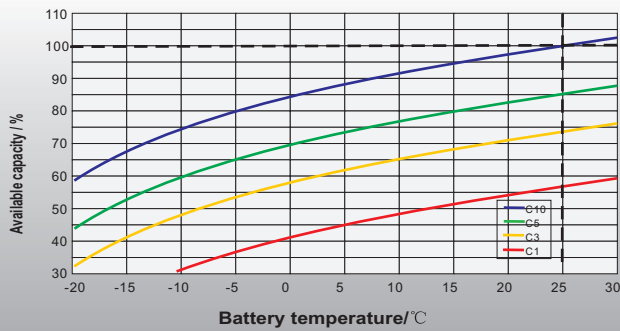

Effect of Temperature on Long Term Float Life

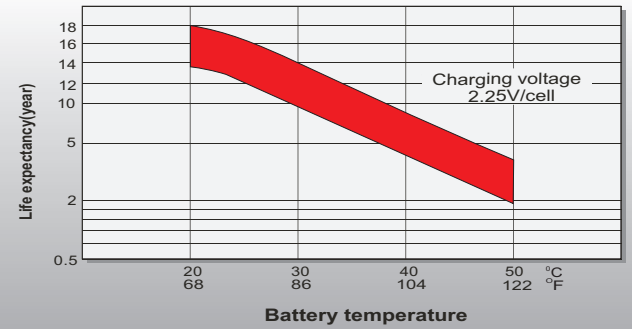

Cycle Life in Relation to Depth of Discharge

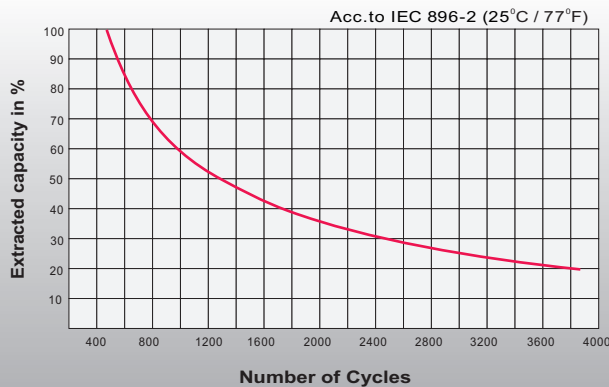

General Relation of Capacity VS. Storage Time

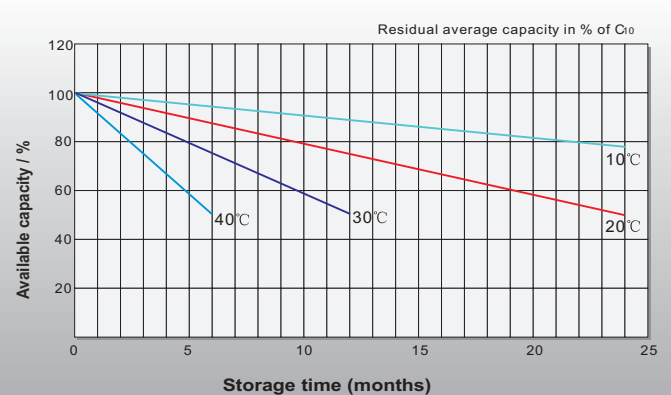

Sales Office

China sales office:

Add: 5th Floor, Xinbaohui Bldg., Nanshan, Shenzhen, China. 518052
Tel: +86-755-86036060 (100 lines)
Fax: +86-755-26067269
E-mail: export@leoch.com

North America sales office:

Add: 19751 Descartes, Unit A, Foothill Ranch, CA 92610, USA
Tel: 949-588-5853
Fax: 949-588-5966
E-mail: sales@leoch.us

Europe sales office:

Add: LaCampagna House. Main Road. Gloucester. GL2-8JH. United Kingdom
Tel: +44(0) 1452 751016
E-mail: Sales.Europe@leoch.com