

LPG SERIES-GEL Battery

LPG2-200 (2V200AH)

Specification

Nominal Voltage	2V	
Nominal Capacity(10HR)	200.0AH	
Dimension	Length	170±2mm (6.69 inches)
	Width	110±2mm (4.33 inches)
	Container Height	328±2mm (12.91 inches)
	Total Height (with Terminal)	350±2mm (13.78 inches)
Approx Weight	Approx 13.3 kg (29.24lbs)	
Terminal	T11	
Container Material	ABS	
Rated Capacity	213.3 AH/106.65A	(20hr, 1.80V/cell, 25°C/77°F)
	200.0 AH/20.00A	(10hr, 1.75V/cell, 25°C/77°F)
	172.0 AH/34.4A	(5hr, 1.75V/cell, 25°C/77°F)
	149.7 AH/49.9A	(3hr, 1.75V/cell, 25°C/77°F)
	117.3 AH/117.3A	(1hr, 1.67V/cell, 25°C/77°F)
Max. Discharge Current	1400A (5s)	
Internal Resistance	Approx 1.13mΩ	
Operating Temp. Range	Discharge	-20~55°C (-4~131°F)
	Charge	0~40°C (32~104°F)
	Storage	-20~50°C (-4~122°F)
Nominal Operating Temp. Range	25±3°C (77±5°F)	
Cycle Use	Initial Charging Current less than 50.0A. Voltage	
	2.4V~2.5V at 25°C(77°F)Temp. Coefficient -5mV/°C	
Standby Use	No limit on Initial Charging Current Voltage	
	2.25V~2.3V at 25°C(77°F)Temp. Coefficient -3mV/°C	
Capacity affected by Temperature	40°C (104°F)	103%
	25°C (77°F)	100%
	0°C (32°F)	86%
Self Discharge	Leoch LPG series batteries may be stored for up to 9 months at 25°C(77°F) and then a freshening charge is required. For higher temperatures the time interval will be shorter.	



Applications

- ◆ Telecommunications
- ◆ Solar system
- ◆ Wind power system
- ◆ Engine starting
- ◆ Wheelchair
- ◆ Floor cleaning machines
- ◆ Golf trolley
- ◆ Boats



Constant Current Discharge (Amperes) at 25 °C (77°F)

F.V/Time	20min	30min	45min	1h	2h	3h	4h	5h	6h	7h	8h	9h	10h	20h
1.85V/cell	174.0	136.8	104.3	90.6	57.8	44.1	36.5	31.5	27.2	24.1	21.7	19.8	18.8	10.24
1.80V/cell	199.8	152.8	115.2	100.0	62.6	47.2	38.7	33.1	28.6	25.2	22.8	20.9	19.6	10.67
1.75V/cell	224.4	168.0	124.3	106.8	66.3	49.9	40.6	34.4	29.6	26.1	23.5	21.5	20.0	10.88
1.70V/cell	241.8	180.0	132.0	113.2	70.3	51.9	41.9	35.4	30.6	27.0	24.2	22.1	20.5	11.03
1.67V/cell	251.4	187.2	136.8	117.3	72.1	53.6	42.9	36.2	31.1	27.4	24.6	22.4	20.7	11.13
1.60V/cell	272.4	200.0	146.9	124.6	75.0	55.7	44.5	37.3	31.9	27.9	25.0	22.8	21.1	11.29

Constant Power Discharge (Watts) at 25 °C (77°F)

F.V/Time	20min	30min	45min	1h	2h	3h	4h	5h	6h	7h	8h	9h	10h	20h
1.85V/cell	330.4	261.6	200.6	175.0	112.1	85.7	71.2	61.7	53.5	47.5	42.9	39.2	37.2	20.3
1.80V/cell	374.4	289.4	219.6	192.2	120.8	91.4	75.2	64.7	56.0	49.5	44.8	41.2	38.7	21.1
1.75V/cell	415.8	314.7	234.7	204.2	127.6	96.4	78.6	66.8	57.7	51.2	46.2	42.4	39.5	21.5
1.70V/cell	443.2	334.8	248.4	215.6	134.6	100.1	80.9	68.7	59.6	52.8	47.5	43.4	40.4	21.8
1.67V/cell	455.5	343.5	255.1	221.7	137.4	102.9	82.7	69.9	60.4	53.4	48.0	43.9	40.8	21.9
1.60V/cell	488.1	364.6	272.6	234.2	142.2	106.5	85.5	71.9	61.7	54.3	48.8	44.8	41.5	22.2

Dimensions

T11 Terminal

Unit: mm [inches]

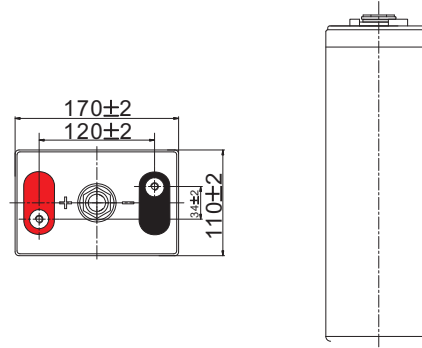
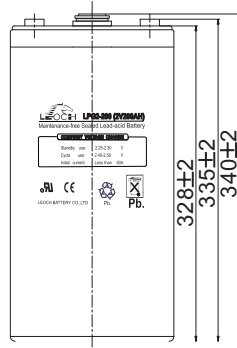
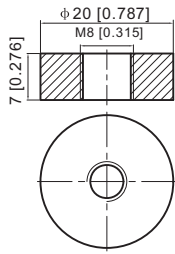

Discharge Characteristics

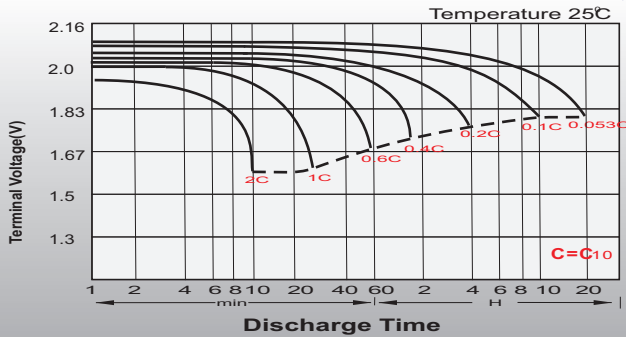

Float Charging Characteristics

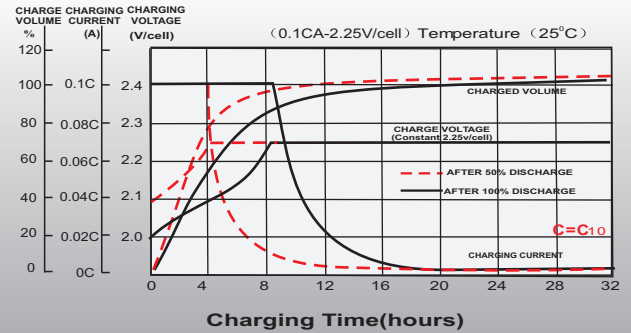

Temperature Effects in Relation to Battery Capacity

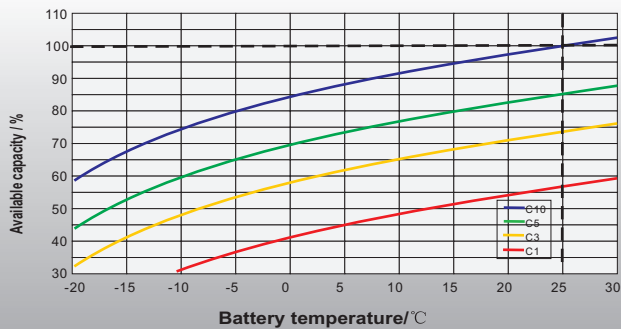

Effect of Temperature on Long Term Float Life

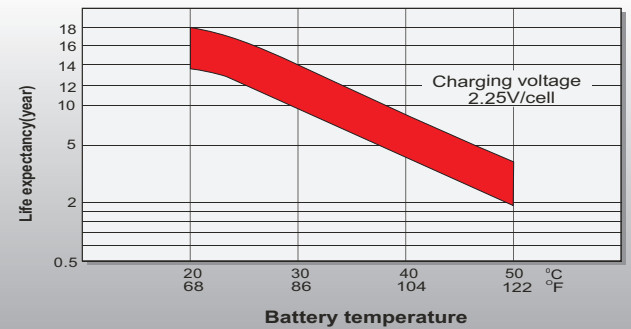

Cycle Life in Relation to Depth of Discharge

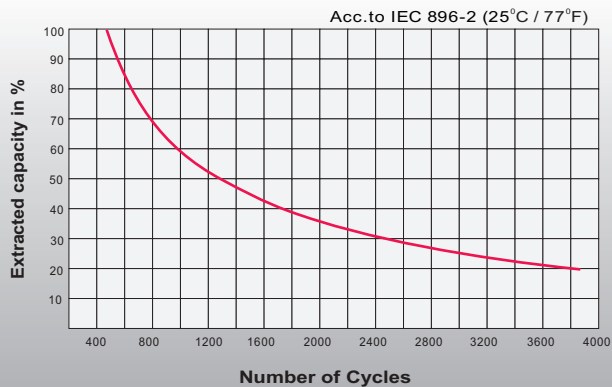

General Relation of Capacity VS. Storage Time

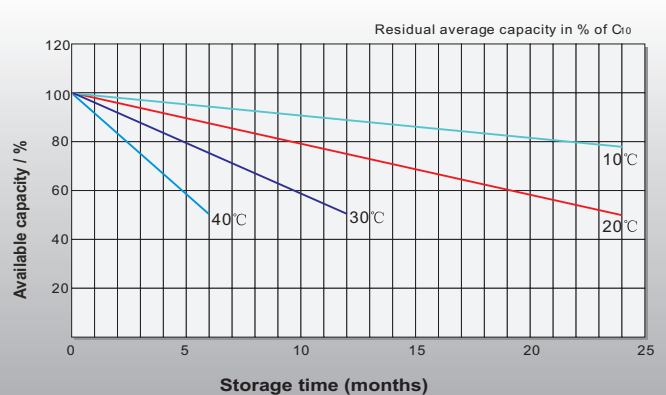

Sales Office

China sales office:

Add: 5th Floor, Xinbaohui Bldg., Nanhai Blvd.,
Nanshan, Shenzhen, China. 518052
Tel: +86-755-86036060 (100 lines)
Fax: +86-755-26067269
E-mail: export@leoch.com

North America sales office:

Add: 19751 Descartes, Unit A,
Foothill Ranch, CA 92610, USA
Tel: 949-588-5853
Fax: 949-588-5966
E-mail: sales@leoch.com

Europe sales office:

Add: LaCampagna House. Main Road.
Gloucester. GL2-8JH. United Kingdom
Tel: +44(0) 1452 751016
E-mail: Sales.Europe@leoch.com