

LPS SERIES-Solar Power

LPS6-230 (6V230AH)

Specification

Nominal Voltage	6V	
Nominal Capacity(100HR)	230.0AH	
Dimension	Length	322±3mm (12.68 inches)
	Width	178±2mm (7.01 inches)
	Container Height	228±2mm (8.98 inches)
	Total Height (with Terminal)	234±2mm (9.21 inches)
	Approx Weight	Approx 32.5 Kg (71.7 lbs)
Terminal	T11	
Container Material	ABS	
Rated Capacity	230.0 AH/2.30A	(100hr ,1.80V/cell,25°C/77°F)
	210.0 AH/10.5A	(20hr ,1.80V/cell,25°C/77°F)
	200.0 AH/20.0A	(10hr,1.80V/cell,25°C/77°F)
	174.5 AH/34.9A	(5hr,1.75V/cell,25°C/77°F)
	1221.5 AH/121.5A	(1hr,1.60V/cell,25°C/77°F)
Max. Discharge Current	2000A (5s)	
Internal Resistance	Approx 1.4mΩ	
Operating Temp. Range	Discharge	-15~50°C (5~122°F)
	Charge	0~40°C (32~104°F)
	Storage	-15~40°C (5~104°F)
Nominal Operating Temp. Range	25±3°C (77±5°F)	
Cycle Use	Initial Charging Current less than 60.0A. Voltage 7.2V~7.5V at 25°C(77°F)Temp. Coefficient -15mV/°C	
	Standby Use No limit on Initial Charging Current Voltage 6.75V~6.69V at 25°C(77°F)Temp. Coefficient -10mV/°C	
Capacity affected by Temperature	40°C (104°F)	103%
	25°C (77°F)	100%
	0°C (32°F)	86%
Self Discharge	Leoch LPS series batteries may be stored for up to 6 months at 25°C(77°F) and then a freshening charge is required. For higher temperatures the time interval will be shorter.	



Applications

- ◆ Green energy systems (solar, wind, hydro, etc)
- ◆ Solar power stations
- ◆ Telecommunications installations
- ◆ Measurement stations
- ◆ Pump systems
- ◆ Signal station
- ◆ Survey and Mapping system
- ◆ Emergency lighting
- ◆ Railway crossing
- ◆ Traffic lights
- ◆ Street lightening
- ◆ Lawn lamp
- ◆ Street signs
- ◆ SOS pillars
- ◆ Alarm installations
- ◆ Weekend cottage camping
- ◆ Caravans
- ◆ Boats or buoys



Constant Current Discharge (Amperes) at 25 °C (77°F)

F.V/Time	15min	20min	30min	45min	1h	2h	3h	4h	5h	8h	10h	20h	48h	100h
1.85V/cell	227.5	189.0	146.8	116.3	94.1	61.3	46.3	37.9	32.0	22.4	19.2	10.2	4.58	2.25
1.80V/cell	252.2	207.9	158.4	123.5	99.2	65.2	48.8	39.7	33.6	23.5	20.0	10.5	4.65	2.30
1.75V/cell	279.8	227.7	170.4	132.0	107.0	68.3	51.5	41.5	34.9	24.2	20.4	10.7	4.73	2.32
1.70V/cell	305.7	248.7	187.2	137.9	113.0	72.0	54.0	43.2	36.3	25.1	21.1	10.9	4.78	2.35
1.65V/cell	323.7	262.5	197.2	146.4	116.9	74.5	56.0	44.7	37.6	25.7	21.5	11.2	4.87	2.39
1.60V/cell	354.8	285.0	209.6	151.7	121.5	77.6	57.9	46.1	38.9	26.4	22.0	11.5	4.95	2.41

Constant Power Discharge (Watts) at 25 °C (77°F)

F.V/Time	15min	20min	30min	45min	1h	2h	3h	4h	5h	8h	10h	20h	48h	100h
1.85V/cell	426.8	358.2	281.3	224.7	183.0	119.7	90.6	74.4	63.1	44.4	38.1	20.3	9.16	4.51
1.80V/cell	466.8	388.2	298.9	235.7	191.3	126.4	95.0	77.6	65.9	46.4	39.7	20.9	9.28	4.59
1.75V/cell	511.5	421.2	318.9	250.7	205.4	131.9	100.0	80.8	68.2	47.7	40.5	21.3	9.41	4.62
1.70V/cell	551.1	456.6	348.4	260.8	216.2	138.7	104.6	84.1	70.9	49.5	41.8	21.7	9.51	4.68
1.65V/cell	581.4	480.1	365.5	275.7	222.9	143.1	108.2	86.8	73.2	50.7	42.7	22.2	9.67	4.74
1.60V/cell	624.3	513.7	384.2	283.0	229.6	147.9	111.1	89.1	75.4	51.9	43.5	22.7	9.83	4.78

Dimensions

T11 Terminal

Unit: mm [inches]

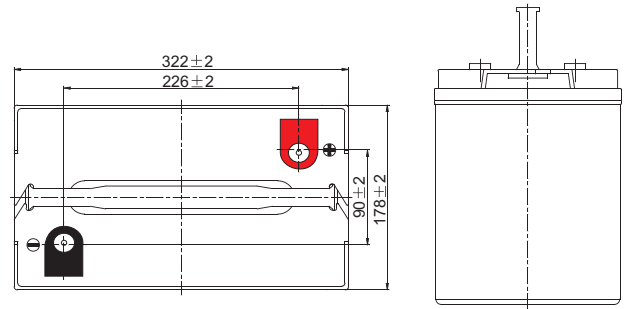
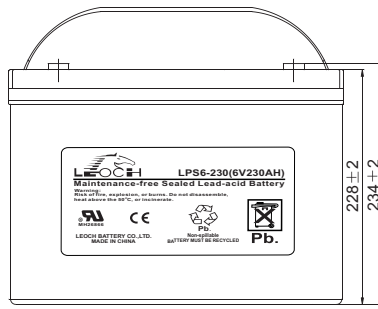
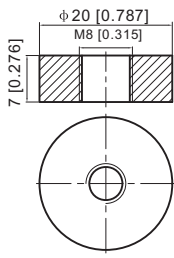

Discharge Characteristics

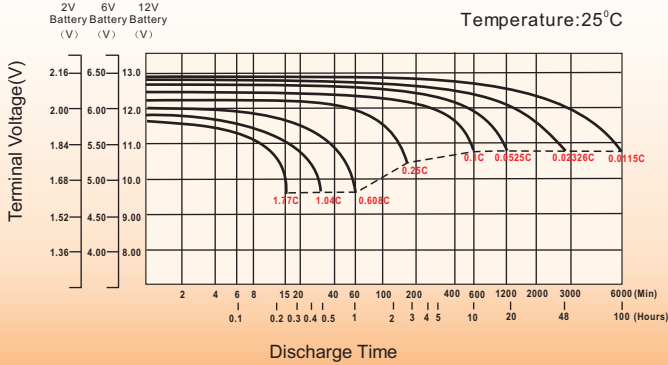

Effect of Temperature on Long Term Float Life

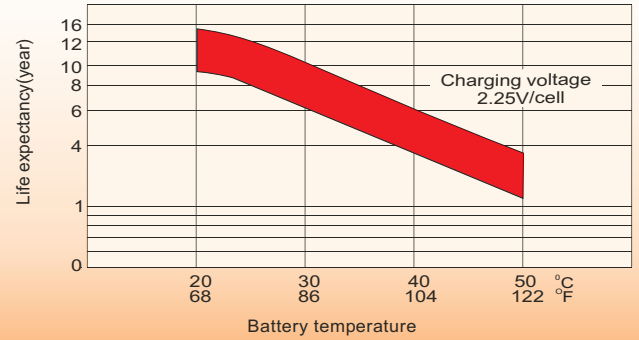

Cycle Service Life

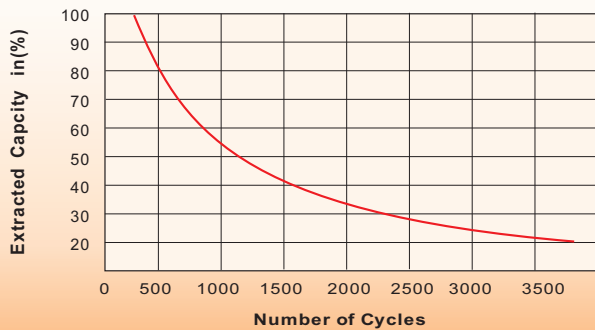

Self-Discharge at Different Temperatures

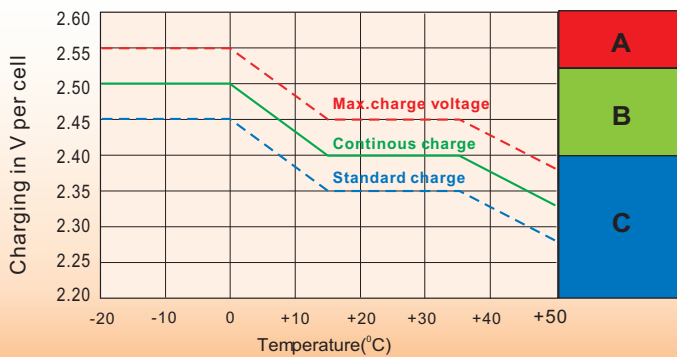
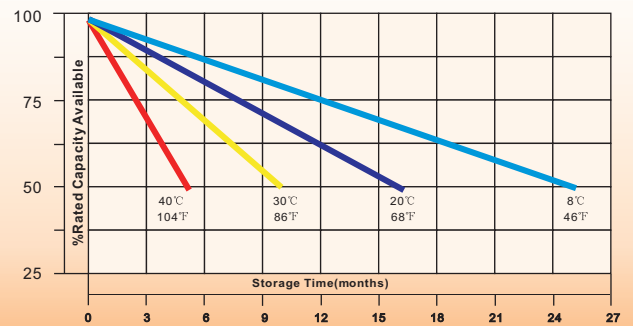

Charge Mode

- A** With switch regulator (two-step controller) charge on curve max.charge voltage for max.2 hrs/day then switch over to continuous charge
- B** Standard charge without switching
- C** Boost charge (Equalizing charge with external generator) charge on curve continuous charge for max. 5 hrs/month, then switch over to curve Standard charge

Sales Office

China sales office:

Add:5th Floor,Xinbaohui Bldg.,Nanhai Blvd.,
Nanshan,Shenzhen, China. 518052
Tel:+ 86-755-86036060 (100 lines)
Fax: +86-755-26067269
E-mail:expopt@leoch.com
Http://www.leoch.com

North Americasales office:

Add: 19751 Descartes, Unit A,
Foothill Ranch, CA 92610, USA
Tel: 949-588-5853
Fax: 949-588-5966
E-mail: sales@leoch.us
Http://www.leoch.us

Europe sales office:

Add: LaCampaña House. Main Road.
Gloucester. GL2-8JH. United Kingdom
Tel: +44(0) 1452 751016
E-mail:Sales.Europe@leoch.com
Http://www.leoch.com