

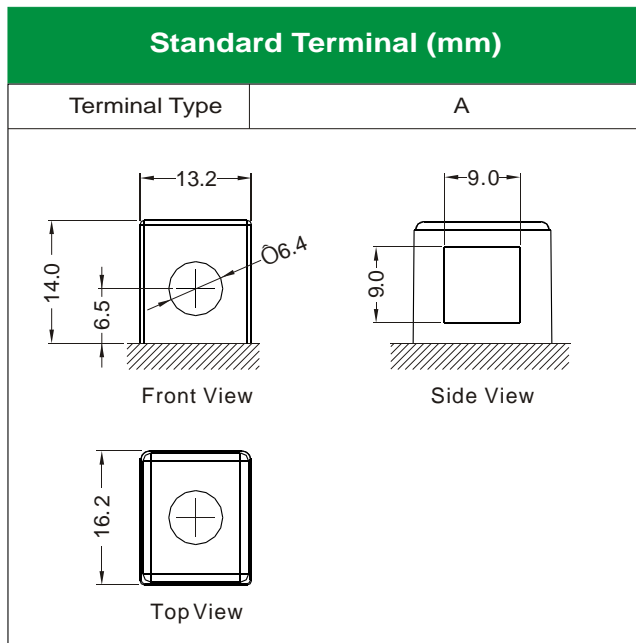

EBX18-BS [12V18Ah]

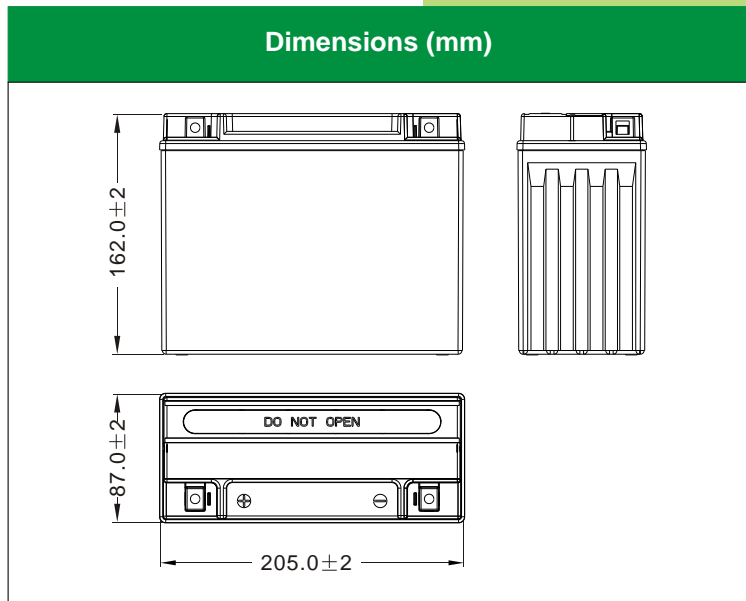

Physical Specification

Nominal Voltage		12V
Nominal Capacity (10HR)		18AH
Dimension	Length	205 ± 2mm (8.07 inches)
	Width	87 ± 2mm (3.43 inches)
	Container Height	162 ± 2mm (6.38 inches)
	Total Height (with Terminal)	162 ± 2mm (6.38 inches)
Weight	Battery(with acid): Approx 6.61kg(14.56lbs) Electrolyte: Approx 1.48kg(3.26lbs)	

- * Sealed and non-spillable AGM battery
- * Maintenance-free
- * Powerful 250 cold cranking amps
- * Shipped pre-charged and ready to install
- * Replaces /upgrade for EB18-4

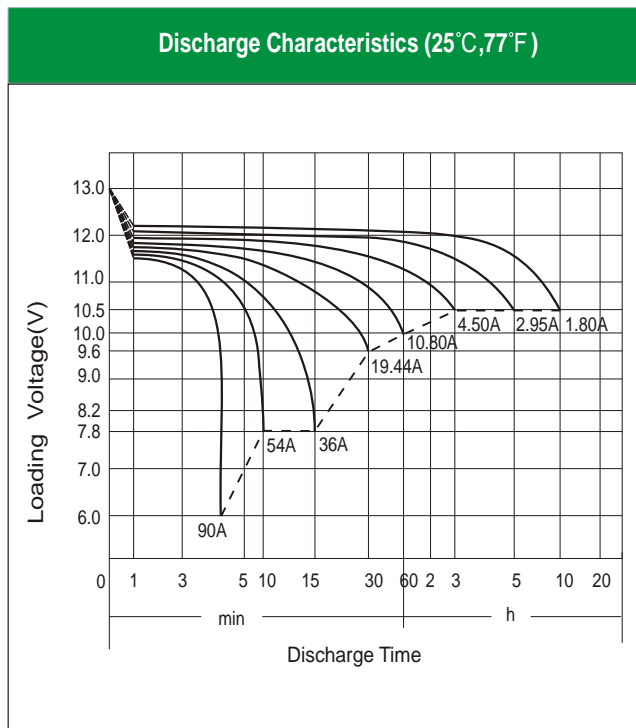

Electrical Specification

Rated Capacity	10 hour rate (1.80 A)	18.00AH
	5 hour rate (2.95 A)	14.76AH
	2 hour rate (6.30 A)	12.60AH
	1 hour rate (10.80 A)	10.80AH
	0.5 hour rate (19.44 A)	9.72AH
Capacity affected by Temperature	40 °C (104 °F)	106%
	25 °C (77 °F)	100%
	0 °C (32 °F)	86%
	-15 °C (5 °F)	65%
Self Discharge	Approximately 3% per month (25°C (77°F))	
Charging Methods	Full Charge	Constant-Voltage Charge: Initial charging current: less than 5.4A Voltage: 14.40 V ~ 15.00 V at 25 °C (77 °F) Charging time: 15 ~18h Constant-Current Charge: Charging current: 0.1C ₁₀ =1.80A, when charging voltage up to 14.40V, continue to charge 4h
	Floating Charge	No limit on Initial charging current Voltage: 13.50 V ~ 13.80 V at 25 °C (77 °F)